

ULTRAGRAPH DIGITAL DEQ1024

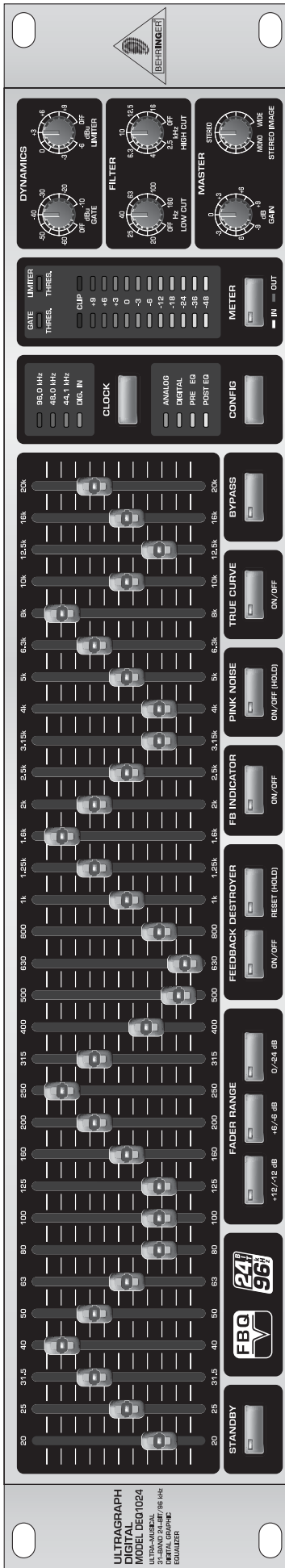

User's Manual

Version 1.0 June 2003

ENGLISH

www.behringer.com



ULTRAGRAPH DIGITAL DEQ1024

IMPORTANT SAFETY INSTRUCTIONS



CAUTION: To reduce the risk of electric shock, do not remove the top cover (or the rear section). No user serviceable parts inside; refer servicing to qualified personnel.

WARNING: To reduce the risk of fire or electric shock, do not expose this appliance to rain and moisture.



This symbol, wherever it appears, alerts you to the presence of uninsulated dangerous voltage inside the enclosure—voltage that may be sufficient to constitute a risk of shock.



This symbol, wherever it appears, alerts you to important operating and maintenance instructions in the accompanying literature. Please read the manual.

DETAILED SAFETY INSTRUCTIONS:

- 1) Read these instructions.
 - 2) Keep these instructions.
 - 3) Heed all warnings.
 - 4) Follow all instructions.
 - 5) Do not use this device near water.
 - 6) Clean only with a dry cloth.
 - 7) Do not block any ventilation openings. Install in accordance with the manufacturer's instructions.
 - 8) Do not install near any heat sources such as radiators, heat registers, stoves, or other apparatus (including amplifiers) that produce heat.
 - 9) Do not defeat the safety purpose of the polarized or grounding-type plug. A polarized plug has two blades with one wider than the other. A grounding type plug has two blades and a third grounding prong. The wide blade or the third prong are provided for your safety. If the provided plug does not fit into your outlet, consult an electrician for replacement of the obsolete outlet.
 - 10) Protect the power cord from being walked on or pinched particularly at plugs, extension cords, and the point at which they exit the unit.
 - 11) Only use attachments/accessories specified by the manufacturer.
 - 12) Use only with the cart, stand, tripod, bracket, or table specified by the manufacturer, or sold with the device. When a cart is used, use caution when moving the cart/device combination to avoid injury from stumbling over it.
- 
- 13) Unplug this device during lightning storms or when not used for long periods of time.
 - 14) Refer all servicing to qualified service personnel. Servicing is required when the unit has been damaged in any way, such as power supply cord or plug is damaged, liquid has been spilled or objects have fallen into the device, the unit has been exposed to rain or moisture, does not operate normally, or has been dropped.

ULTRAGRAPH DIGITAL

Digital Stereo 31-Band 24-Bit/96 kHz Equalizer/Feedback Destroyer/Dynamics Processor

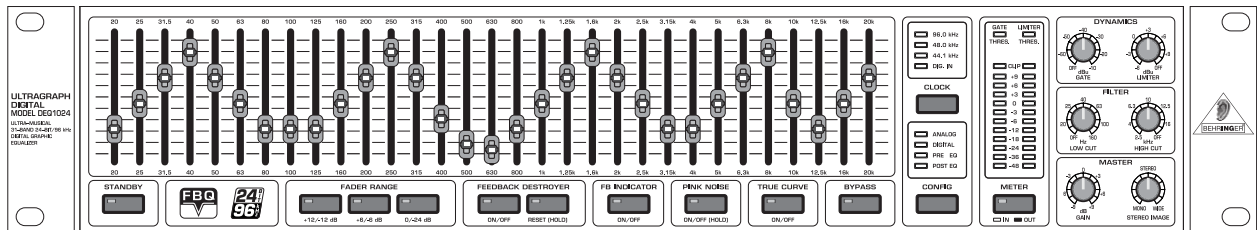

- ▲ Ultra high-resolution processor for all EQ, RTA and dynamic applications, especially for PA and audiophile mastering
- ▲ Unique TRUE CURVE Function—what you see on the faders is what you get as frequency response
- ▲ Revolutionary FBQ DETECTION system instantly reveals critical frequencies and can also be used as Audio Analyzer
- ▲ Automatic and ultra-fast Feedback Destroyer plus feedback indication via fader LEDs
- ▲ “Inaudible” Noise Gate/Peak Limiter function plus amazing Stereo Imager for spatial enhancement
- ▲ Additional sweepable high and low cut filters for removal of unwanted frequencies like floor rumble and high-frequency noise
- ▲ Integrated Pink Noise generator for perfect room and loudspeaker equalization
- ▲ Digital AES/EBU and S/PDIF interface and selectable sample rates (44.1, 48, 96 kHz)
- ▲ Ultra high-resolution 24-bit/96 kHz A/D- and D/A converters and high-performance 24/48-bit MOTOROLA® DSP for ultimate sonic resolution
- ▲ Relay-controlled hard-bypass with an auto-bypass function during power failure (failsafe relay)
- ▲ Highly accurate, 2 x 12-digit LED meters for easy input and output level setting
- ▲ Ultra high-quality, illuminated 45-mm faders, sealed rotary controls and illuminated switches
- ▲ Servo-balanced inputs and outputs on gold-plated XLR and ¼" TRS connectors
- ▲ Internal switch-mode power supply for maximum flexibility (100 - 240 V~), noise-free audio, superior transient response and lowest possible power consumption
- ▲ Extremely rugged construction ensures long life even under the most demanding conditions
- ▲ Designed in Germany. Manufactured under ISO9000 certified management system

ULTRAGRAPH DIGITAL DEQ1024

FOREWORD



Dear Customer,

welcome to the team of BEHRINGER users, and thank you very much for expressing your confidence in us by purchasing the DEQ1024.

Writing this foreword for you gives me great pleasure, because it represents the culmination of many months of hard work delivered by our engineering team to achieve a very ambitious goal: to present an outstanding piece of equipment that can be used in both live and studio applications

thanks to its enormous flexibility. The task of designing our new DEQ1024 certainly meant a great deal of responsibility, which we assumed by focusing on you, the discerning user and musician. Meeting your expectations also meant a lot of work and night shifts. But it was fun, too. Developing a product usually brings a lot of people together, and what a great feeling it is when all who participated in such a project can be proud of what they've achieved.

It is our philosophy to share our enjoyment with you, because you are the most important member of the BEHRINGER team. With your highly competent suggestions for new products you've made a significant contribution to shaping our company and making it successful. In return, we guarantee you uncompromising quality as well as excellent technical and audio properties at an extremely reasonable price. All of this will enable you to give free rein to your creativity without being hampered by budget constraints.

We are often asked how we manage to produce such high-quality devices at such unbelievably low prices. The answer is quite simple: it's you, our customers! Many satisfied customers mean large sales volumes enabling us to get better purchasing terms for components, etc. Isn't it only fair to pass this benefit on to you? Because we know that your success is our success too!

I would like to thank all of you who have made the DEQ1024 possible. You have all made your own personal contributions, from the developers to the many other employees at this company, and to you, the BEHRINGER user.

My friends, it's been worth the effort!

Thank you very much,

Uli Behringer

TABLE OF CONTENTS

1. INTRODUCTION	5
1.1 Before you get started	5
1.1.1 Shipment	5
1.1.2 Initial operation	5
1.1.3 Warranty	5
1.2 The user's manual	5
2. CONTROL ELEMENTS	6
2.1 Front panel	6
2.2 Rear panel	9
3. APPLICATIONS	9
3.1 Master equalizer in sound reinforcement systems	10
3.2 Equalizer in the monitor path	10
3.2.1 Priming a monitor system	11
3.3 Using the ULTRAGRAPH DIGITAL in the studio	11
3.4 Special sound effects	11
4. INSTALLATION	12
4.1 Rack mounting	12
4.2 Audio connections	12
4.3 Digital connections (AES/EBU and S/PDIF)	12
5. SPECIFICATIONS	13
6. WARRANTY	14

1. INTRODUCTION

Thank you very much for expressing your confidence in BEHRINGER products by purchasing the ULTRAGRAPH DIGITAL DEQ2496, an extremely high-quality digital equalizer with built-in 24-bit/96 kHz A/D and D/A converters, making it an ideal tool for both live and studio applications.

In addition to graphic EQing, the ULTRAGRAPH DIGITAL gives you a wide array of additional functions, such as feedback destroyer, pink noise generator, limiter/noise gate etc., leaving no wishes open. With these and many more features the DEQ1024 is an absolutely all-purpose device for your recording or mastering studio and will definitely upgrade your equipment.

 **The following user's manual is intended to familiarize you with the unit's control elements, so that you can master all the functions. After having thoroughly read the user's manual, store it at a safe place for future reference.**

1.1 Before you get started

1.1.1 Shipment

The DEQ1024 was carefully packed at the factory to assure secure transport. Should the condition of the cardboard box suggest that damage may have taken place, please inspect the unit immediately and look for physical indications of damage.

 **Damaged units should NEVER be sent directly to us. Please inform the dealer from whom you acquired the unit immediately as well as the transportation company from which you took delivery of the unit. Otherwise, all claims for replacement/repair may be rendered invalid.**

1.1.2 Initial operation

Please make sure the unit is provided with sufficient ventilation, and never place the ULTRAGRAPH DIGITAL on top of an amplifier or in the vicinity of a heater to avoid the risk of overheating.

 **Faulty fuses must be replaced with fuses of appropriate rating without exception! The correct value of the fuses needed can be found in the chapter "SPECIFICATIONS".**

Power is delivered via the cable enclosed with the unit. All required safety precautions have been adhered to.

 **Please make sure that the unit is grounded at all times. For your own protection, you should never tamper with the grounding of the cable or the unit itself.**

1.1.3 Warranty

Please take a few minutes and send us the completely filled out warranty card within 14 days of the date of purchase. You may also register online at www.behringer.com. The serial number needed for the registration is located at the top of the unit. Failure to register your product may void future warranty claims.

1.2 The user's manual

The user's manual is designed to give you both an overview of the control elements, as well as detailed information on how to use them. In order to help you understand the links between the controls, we have arranged them in groups according to their function. If you need to know more about specific issues, please visit our website at www.behringer.com, where you'll find additional information on mixing consoles, effects units and dynamic processors.

ULTRAGRAPH DIGITAL DEQ1024

2. CONTROL ELEMENTS

2.1 Front panel

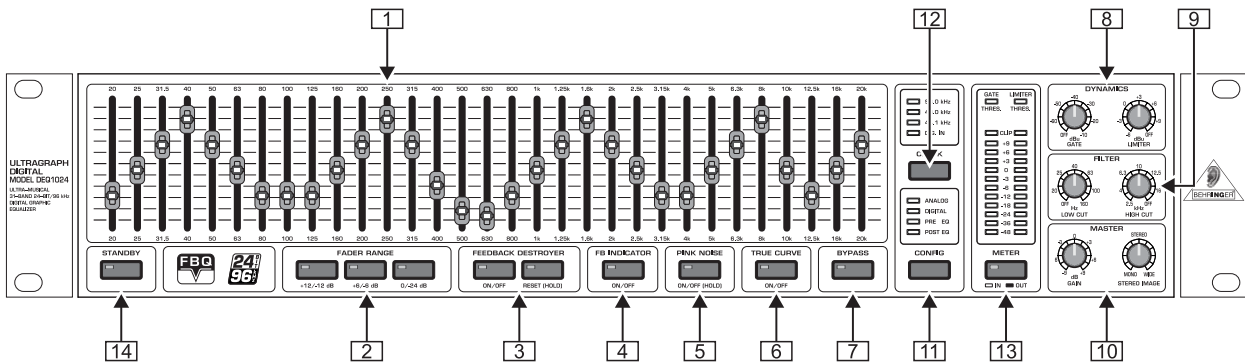

Fig. 2.1: Front panel control elements

- 1 Use the 45-mm EQ faders to increase or decrease any one of the 31 frequency bands. Each fader has its own red LED.
- 2 Use the *FADER RANGE* switches to regulate increasing/decreasing in three different levels: +12/-12 dB (green LED), +6/-6 dB (green LED) and 0/-24 dB (yellow LED). The last option is well suited for eliminating feedback frequencies, since you can select a very pronounced lowering of a specific frequency range (-24 dB).
- 3 The DEQ1024 features an automatic *FEEDBACK DESTROYER*.

Activating the FEEDBACK DESTROYER:

When you press the *ON/OFF* switch (yellow LED lights up), the feedback destroyer scans the audio signal for feedback frequencies. As soon as one or more frequencies show feedback, the red LED of the *RESET (HOLD)* switch lights up. The affected frequencies are then automatically lowered. In addition, your audio program is constantly scanned for new feedback frequencies, and feedback is destroyed as it comes up. This makes sense for microphones that are in constant motion during a stage performance (e. g. vocal microphones), where feedback may arise constantly.

Deactivating the search function (feedback suppression remains active):

If you now press the *ON/OFF* switch for a second time, the feedback analysis stops. Those frequencies emitting feedback will continue being lowered (*RESET (HOLD)* LED is still on). This procedure is well suited for stationary microphones, such as drum microphones. To start the "hunt" for feedback again, hit the *ON/OFF* switch once again.

Displaying the feedback frequencies:

If you briefly (for approx. 2 seconds) depress the *RESET (HOLD)* switch, the feedback frequencies that the DEQ1024 was able to find will be indicated on the respective fader LEDs. If no feedback occurs, the LEDs will stop being lit up for roughly 2 seconds.

Deactivating the FEEDBACK DESTROYER:

If you hold the *RESET (HOLD)* switch depressed for a few seconds, the filter settings are reset (*RESET (HOLD)* LED dies out) and the *FEEDBACK DESTROYER* is deactivated.

- 4 If you press the *FB INDICATOR* switch (green switch LED lights up), the FBQ feedback detection system is activated. The frequency (or the frequencies) that cause feedback are now shown in the form of a brightly shining fader LED. All other LEDs are dimmed. Simply lower somewhat the pertinent frequency range until feedback is no longer present and the LED dies out.
- By displaying the intensity of individual frequency ranges, the feedback recognition system also functions as an audio analyzer.
- 5 Please keep in mind that the *FB INDICATOR* only shows the intensity of the individual frequency bands. Not every frequency that is present automatically causes feedback.

FEEDBACK DESTROYER and FB INDICATOR function independently from one another and can be activated simultaneously. Please bear in mind: when in 96-kHz mode, FEEDBACK DESTROYER and FB INDICATOR are not available!

- 5 When you keep the *PINK NOISE* switch depressed for a few seconds, the internal pink noise generator of your DEQ1024 is activated (red switch LED lights up) and the volume level of the test signal is gradually increased as long as the switch remains depressed (the level is shown on *LEVEL METER* 13). Briefly pressing the *PINK NOISE* switch once again deactivates the function.

PINK NOISE

Room resonance and the transmission characteristics of your P.A. system naturally lift certain frequencies while lowering others. Pink noise is a neutral signal that can be played back over the P.A. system in order to measure these room characteristics. One such measurement of the frequency response with a special measurement microphone (e. g. BEHRINGER ECM8000) coupled to a real-time analyzer (integrated in the BEHRINGER ULTRACURVE PRO DEQ2496) delivers the foundation for setting up the equalizer. Boosted frequencies can be lowered by means of your equalizer, while frequencies that are too weak can be boosted, and a nearly linear playback is achieved.

ULTRAGRAPH DIGITAL DEQ1024

 Try to orient yourself on a frequency whose signal level lies in the 0 dB to -3 dB range in order to avoid **overdriving** the equipment connected (e. g. amp, crossover).

6 In the world of ordinary graphic equalizers, there is always a difference between the adjusted curve and the resulting frequency response. This phenomenon is simply caused by the construction of such equalizers. This difference depends on the frequency and its cut/boost. Near-by frequency bands influence one another, whereby individual instances of cut or boost can also be added up to one another.

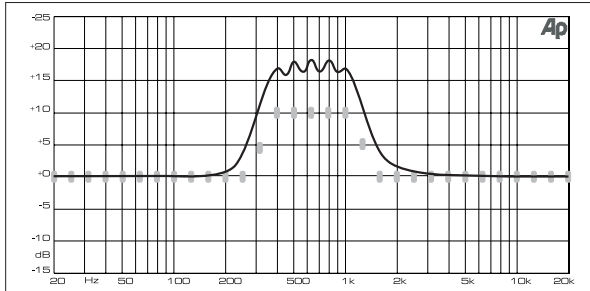

Fig. 2.2: Graphic equalizer without frequency response correction

This occurrence can be corrected by means of a specially developed algorithm utilized in the ULTRAGRAPH DIGITAL DEQ1024. Simply press the *TRUE CURVE* switch (green switch LED lights up).

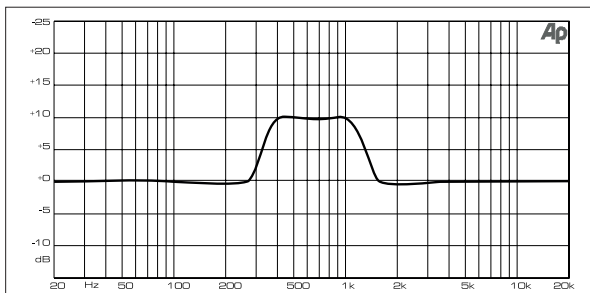

Fig. 2.3: Graphic equalizer with frequency response correction (*TRUE CURVE*)

The resulting frequency response now corresponds exactly to the settings that you adjusted with the graphic equalizer.

7 The *BYPASS* switch lets you directly compare the processed and unprocessed audio program. When the *BYPASS* function is activated (red switch LED lights up), the input of the unit is directly forwarded to the output so you can monitor the unprocessed signal.

8 The *DYNAMICS* section of the DEQ1024 consists of a *GATE* and a *LIMITER*. Use the *GATE* and *LIMITER* controls to determine the threshold. When the threshold is exceeded (*LIMITER*) or when the signal falls below the threshold (*GATE*), the dynamic processors starts affecting the signal.

GATE

When the input signal falls below the threshold value, the signal is completely faded out. Tape hiss, crosstalk or disturbing noise can thus be effectively removed from the signal. The yellow *GATE* LED in the *METER* section (see **13**) lights up as soon as the *GATE* closes. The range of the threshold lies between -60 and -10 dB. When turned all the way to the left, the *GATE* is deactivated (*OFF*).

LIMITER

The *LIMITER* protects your equipment from signal peaks that could for example damage your speakers. Output signal levels that exceed the selected threshold value are limited, and the red *LIMITER* LED in the *METER* section (see **13**) lights up. By reducing signal dynamics, a more expressive sound is achieved. The threshold range lies between -6 and +9 dB. When turned all the way to the right, the *LIMITER* is deactivated (*OFF*).

 Please keep in mind that **boosting many frequency bands also increases the output signal level. In this case, the limiter is activated sooner. You can avoid this by achieving signal correction not only by boosting frequency bands but by also lowering signal levels. To achieve creative sound effects, the peak limiter can deliberately be driven to its limits.**

9 The DEQ1024 features a *LOW CUT* and *HIGH CUT* filter in its *FILTER* section, allowing you to limit the entire frequency spectrum upward or downward. The *HIGH CUT* control is used to determine the cut-off frequency above which the high frequency range is lowered (2.5 - 16 kHz). When turned all the way to the right, the filter is deactivated (*OFF*). The *LOW CUT* control is used to determine the cut-off frequency above which the low frequency range is lowered (20 - 160 Hz). When turned all the way to the left, the filter is deactivated (*OFF*).

10 Use the *GAIN* control in the *MASTER* section to determine the output volume of the ULTRAGRAPH DIGITAL in the range between -9 to +9 dB. In addition, there is also a stereo imager function that lets you adjust the stereo width and therefore the separation between the left and the right stereo side. When the *STEREO IMAGE* control is turned all the way to the right, you achieve the maximum widening of the stereo signal (*WIDE*); when the control is turned all the way to the left, the stereo signal is transformed into a mono signal (*MONO*). When the *STEREO IMAGE* control is in its middle position, your signal is not processed (*STEREO*).

11 When you keep the *CONFIG* switch depressed for a few seconds, you can select the operating mode of your DEQ1024: *ANALOG* (green LED), *DIGITAL* (yellow LED), *PRE EQ* (yellow LED) or *POST EQ* (yellow LED). When in the *PRE EQ* or *POST EQ* mode, you can use the rear panel digital connectors as inserts, for example for an additional dynamics processor. When the unit is in *PRE EQ* mode, the insert point is located pre EQ; when the unit is in *POST EQ* mode, the insert point is located post EQ (see fig. 2.5 and 2.6).

ULTRAGRAPH DIGITAL DEQ1024

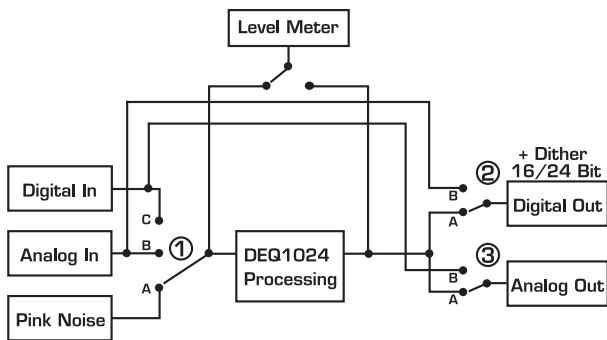

Fig. 2.4: Input/output wiring depending on operating mode

CONFIG	Pink Noise ON		
	1	2	3
Analog	B	A	A
Digital	C	A	A
Pre EQ	C	B	A
Post EQ	B	A	B

Tab. 2.1: Input/output wiring depending on operating mode

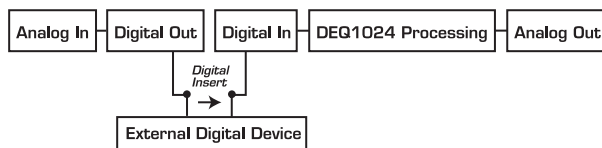

Fig. 2.5: Signal flow in PRE EQ mode

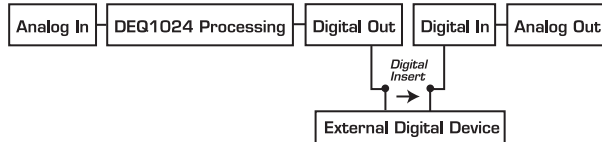

Fig. 2.6: Signal flow in POST EQ mode

- 12 When you keep the *CLOCK* switch depressed for a few seconds, you can select the desired sample rate with which your DEQ1024 is working: 44.1 kHz, 48 kHz or 96 kHz (green LEDs). To synchronise your DEQ1024 with the sample rate of an external unit (e. g. through a digital mixing console), you have to select the *DIG IN* setting (yellow LED lights up).

☞ If you select the *DIG IN* setting, although no signal is connected to the digital input, the DEQ1024 is not able to synchronise with any sample frequency (yellow *DIG IN* LED is blinking). In this case the ULTRAGRAPH DIGITAL switches to the sample frequency last connected to the digital input. If you connect a signal to the digital input while operating in the unsynchronised mode, your DEQ1024 switches back to normal mode and synchronises with the connected sample frequency (yellow LED lights up).

To select the word length of the digital output signal (16 bit or 24 bit), keep the *CONFIG* and *CLOCK* switches simultaneously pressed. The 24-bit setting is shown by means of the -24 dB LEDs in the *METER* display (see 13). When the 16-bit setting is selected, no *METER* LED lights up. This way, the DEQ1024 can be adjusted to the 16-bit inputs of DAT and CD recorders or sound cards. The analog output signal is always converted with 24 bit, independent of the above setting.

- 13 The 12-digit *LEVEL METER* shows the signal level of the input and output signals. Use the *METER* switch located below it to select the respective signal, whereby the output signal is indicated when the switch LED lights up (green), and the input signal is indicated when the switch LED is not lit. The red *CLIP* LED lights up as soon as the indicated signal is overdriven. The *GATE* and the *LIMITER* LED shows that the threshold of the respective dynamics processors is either exceeded or is below the selected value; the LED also indicates that the dynamics processor is active at this time (see 8). Additionally, the volume of the pink noise generator and the 24-bit word length setting (see 12) is shown on the LED *METER*.
- 14 Keeping the *STANDBY* switch depressed for a few seconds puts the DEQ1024 into standby mode (red switch LED lights up). In this case, the signal connected to the DEQ1024 is looped through without being processed.
- ☞ All new settings are saved after approx. 2 seconds, so that powering the DEQ1024 off and then on again (by using the *STANDBY* or the *POWER* switch 20 on the rear panel) recalls the current settings.

ULTRAGRAPH DIGITAL DEQ1024

2.2 Rear panel

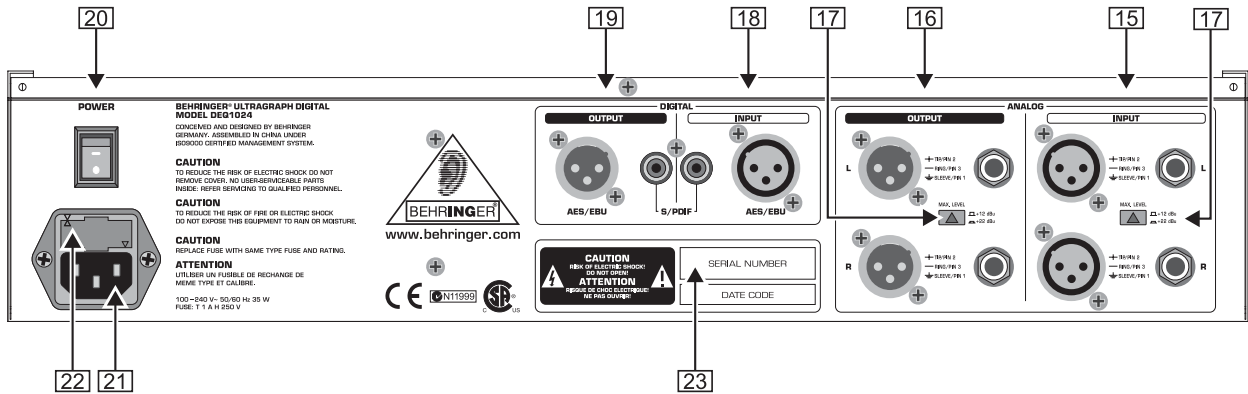



Fig. 2.7: Rear panel control elements and connectors

- 15 The balanced XLR and 1/4" TRS inputs are used for connecting an analog input signal.
- 16 The analog output signal of the DEQ1024 can be taken by using these balanced XLR and 1/4" TRS connectors.
- 17 The *MAX. LEVEL* switches increase the maximum signal level on the analog inputs and outputs from +12 dBu to +22 dBu.
- 18 You can selectively connect an input signal in the AES/EBU format (via the XLR connector) or in the S/PDIF format (via the RCA connector) to the digital inputs. In PRE EQ and POST EQ modes, these connectors can also be used as insert returns (see 11). Here, you can connect the output of your dynamics processor or similar equipment.
-  **Never connect a signal simultaneously to the AES/EBU and to the S/PDIF input.**
- 19 The output signal is available on the digital output in the AES/EBU format (XLR connector) and in the S/PDIF format (RCA connector). In PRE EQ or POST EQ mode you can use these connectors as insert sends (see 11). Connect the input of your external dynamics processor or similar equipment here. Unlike with the digital inputs, both digital outputs can be used simultaneously.
- 20 The *POWER* switch powers up your ULTRAGRAPH DIGITAL. The *POWER* switch should always be in its "Off" position when you are about to connect the DEQ1024 to the mains.
-  **Attention: The *POWER* switch does not fully disconnect the unit from the mains. Unplug the power cord completely when the unit is not used for prolonged periods of time.**
- 21 The mains connection is achieved via the standard IEC connector. A matching power cord is included.
- 22 You can exchange blown fuses that are located in the FUSES COMPARTMENT of your DEQ1024. Blown fuses must be replaced by fuses of the same type and rating. Please refer to chapter 5 "SPECIFICATIONS" for further details.
- 23 *SERIAL NUMBER* of the ULTRAGRAPH DIGITAL. Please take the time to fill in and return the warranty card within 14 days after the date of purchase. Or register online at www.behringer.com.

3. APPLICATIONS

The flexible concept of the ULTRAGRAPH DIGITAL, with its wide-ranging possibilities for audio processing, opens up many application options. We will now present to you some of those possibilities with their typical settings.

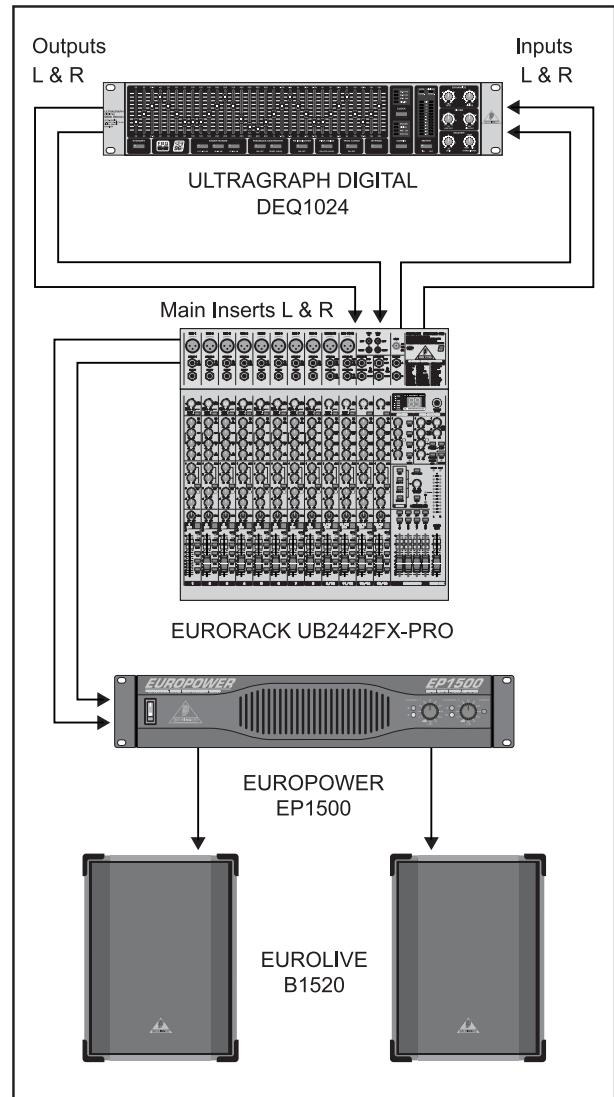

Fig. 3.1: The ULTRAGRAPH DIGITAL DEQ1024 as master equalizer

ULTRAGRAPH DIGITAL DEQ1024

3.1 Master equalizer in sound reinforcement systems

This is surely the most common DEQ1024 application.

To achieve optimal results, you should keep in mind the following:

Before you begin correcting the frequency response, running your audio program “unprocessed” first has proved itself useful. If distortion occurs, it should first be confronted within the P.A. system. The physical location of your loudspeakers also plays a huge role. No equalizer in the world can majorly improve the sound that was thoroughly wattered down by being bounced off the walls and ceilings. Modifying speaker positioning alone can create major improvements in the quality of your sound.

When using multi-way active speakers, you should also first correct the run-time and phase settings (the ULTRADRIVE PRO DCX2496 digital crossover from BEHRINGER gives you all the tools needed for this). Only then does the ULTRAGRAPH DIGITAL come into play. Background noise such as mains hum as well as extremely narrow-band resonance should first be eliminated by using the DEQ1024 (also see ch. 3.2.1). This should definitely be done before setting up the sound.

After this editing, you have a basic setup; now, you can do some manual fine-tuning, if necessary.

The following is true:

A linear response curve is not ideal for every application. For example, when dealing with voice transmission, being able to understand the speaker is the most important factor. Therefore, the response curve should drop away in the bass range, since the voice can carry subsonic noise and floor rumble.

As a rule, extremely low and extremely high frequencies are transmitted much weaker. It makes no sense to burden a small P.A. system with frequencies below 50 Hz; the only result in addition to the higher power consumption would most likely be expensive repair costs.

Always keep in mind where the physical limitations of your system are.

Upon setting up your system as accurately as possible to the desired response curve, walk around the listening area so you can get an idea what your system sounds like from various positions. Don't forget to implement frequent pauses and a various music selection into your program. You will get a better feeling for the transmission characteristic of your system as well as of the room/auditorium itself.

Achieving good EQ settings requires a lot of time and patience! If extreme settings of your EQ are required in order to produce a useful frequency response, this should be seen as an alarm sign that a serious error or defect is present somewhere in your sound system, be it in room acoustics or in your equipment.

An equalizer is no solution that can make up for a poor P.A. system, but it is an extremely useful and effective sound tool for musical fine tuning. Fine tuning often lets you create amazing results and improvements in acoustic penetration and in the overall quality of your sound.

3.2 Equalizer in the monitor path

Basically, the on-stage volume level should be kept as low as possible, because:

1. it will be easier on your hearing,
2. there are less feedback problems, and
3. it's easier to achieve a good front-of-house sound.

Often, the volume of the monitor speakers is raised as a concert goes on. Use breaks and pauses to reduce all monitor paths by about 3 dB. The musicians will not or hardly hear that the volume has been reduced, because during a break their hearing can relax a bit. This gives you valuable headroom in your system.

Extremely low frequencies are usually faded out completely to avoid a “muddy” sound on stage caused by low-frequency feedback. Use the low-cut filter for this purpose and set it up in such a way so that extremely deep feedback disappears, creating a transparent-sounding monitor sound.

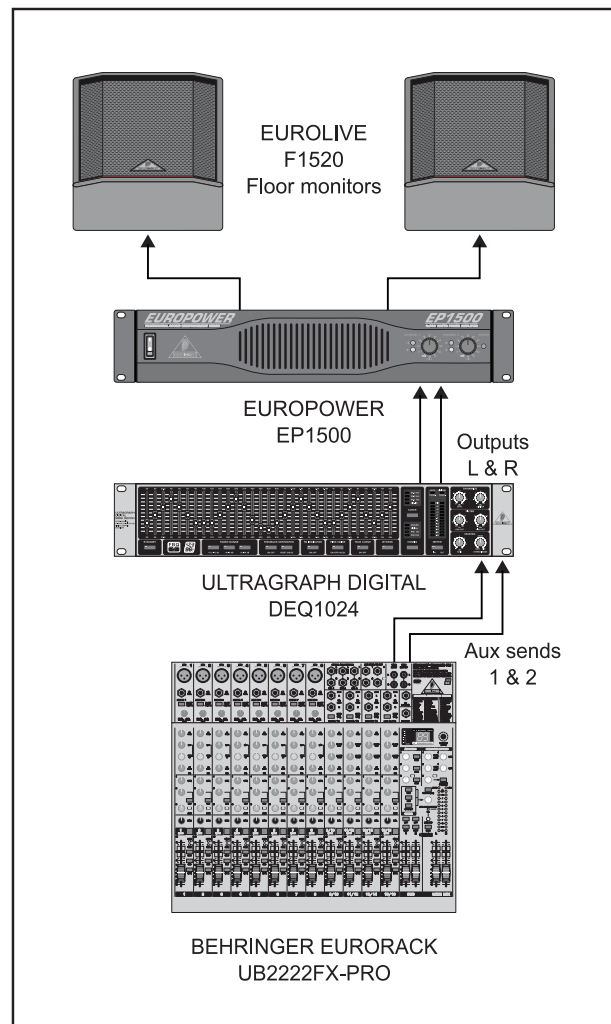

Fig. 3.2: The ULTRAGRAPH DIGITAL DEQ1024 in a monitor system

3.2.1 Priming a monitor system

Priming describes the process of detecting and suppressing feedback frequencies. After placing and setting up your microphones and monitor speakers (including amplifiers), you should crank up the aux send controls on all the channels of your mixing console needed for the monitor mix.

Now, activate the feedback detection system by pressing the FB INDICATOR switch [4]. The fader LEDs [1] indicate the intensity of the individual frequency bands. Then, use the aux send master controls to increase the amplification on your mixing console until you first begin to notice feedback. Possible feedback frequencies are now indicated on the fader LEDs that are lit up most brightly.

Frequency ranges that cause feedback can now be lowered by using the respective EQ faders. Repeat this procedure to detect additional feedback frequencies. After having worked on all critical frequencies, when you crank up the aux send master control, you will be able to hear only negligible multi-frequency feedback. Your monitor system has now achieved its maximum volume.

Leave the other faders in the middle position as long as there is no need to proceed with frequency correction (e.g. measuring with a real-time analyzer). Now, adjust the desired stage volume, and you will have tons of available headroom without causing feedback problems.

3.3 Using the ULTRAGRAPH DIGITAL in the studio

Additional applications of your DEQ1024 are possible in the studio. Your imagination has no limits. Here are only some of the examples:

As equalizer for your studio monitors:

You can perform graphic equalization of your monitor sound. Besides, you can suppress narrow-band room resonances. An analyzer, such as the one integrated into the BEHRINGER digital equalizer ULTRACURVE PRO DEQ2496, can help you in your search for room resonances and a linear frequency response.

For general sound processing:

The equalizer lets you process both individual and sum signals. To process individual signals, you should connect the ULTRAGRAPH DIGITAL via the channel insert on your mixing console. To control several signals, either use a subgroup or a main insert. Especially in mastering studios, the sound of a finished mix is nowadays still processed with equalizers. Often, the mixes are not evened out, meaning certain frequency ranges are featured too prominently while others can hardly be heard. A graphic equalizer lets you even out the intensity of such frequency ranges, so you end up with a homogenous sound characteristics.

3.4 Special sound effects

Be it in the studio, on the stage or in radio plays, the ULTRAGRAPH DIGITAL can become an indispensable tone tool. You can for example change the sound of a voice so that it sounds like it's coming through the phone, or you can prominently filter the sound of instruments so that they fit well into an existing mix.

The following tables represent the connection between frequencies and their acoustic meaning. They should encourage you to start using your DEQ1024 in many creative ways.

Center frequency (Hz) 1/3 octave	Effect on voice
40 to 125	Sense of power in some outstanding bass singers.
160 to 250	Voice fundamentals.
315 to 500	Important for voice quality.
630 to 1k	Important for voice naturalness. Too much boost in the 315 to 1 kHz range produces a telephone-like quality.
1.25k to 4k	Voice fricatives-accentuation of vocals. Important for speech intelligibility. Too much boost between 2 and 4 kHz can mask certain speech sounds e.g. "m", "b", and "v" can become indistinguishable. Too much boost anywhere between 1 and 4 kHz can produce "listening fatigue". Vocals can be highlighted by slightly boosting the vocal at 3 kHz and at the same time slightly dipping the instruments at the same frequency.
5k to 8k	Accentuation of voice. The range from 1.25 to 8 kHz governs the clarity of voice.
10k to 16k	Too much boost causes sibilance.

Tab. 3.1: Frequency allocation (voice)

Center frequency (Hz) 1/3 octave	Effects on music
31 to 63	Fundamentals of bass drum, tuba, double bass and organ. These frequencies give music a sense of power. If over-emphasised they make the music "muddy". The 50 or 60 Hz band is also used to reject AC mains hum.
80 to 125	Fundamentals of lower tympani. Too much boost produces excessive "boom". 100 or 125 Hz are also used for hum rejection.
160 to 250	Drum and lower bass. Too much boost produces excessive "boom". Also useful for 3rd harmonic mains hum rejection.
315 to 500	Fundamentals of strings and percussion.
630 to 1k	Fundamentals and harmonics of strings, keyboards and percussion. Boosting the 600 to 1 kHz range can make instruments sound horn-like.
1.25k to 4k	Drums, guitar, accentuation of vocals, strings and bass. Too much boost in the 1 to 2 kHz range can make instruments sound tinny. Too much boost anywhere between 1 to 4 kHz can produce "listening fatigue".
5k to 8k	Accentuation of percussion, cymbals and snare drum. Reduction at 5 kHz makes overall sound more distant and transparent. Reduction of tape hiss and system noise. The 1.25 to 8 kHz governs clarity and definition.
10k to 16k	Cymbals and overall brightness. Too much boost causes sibilance. Reduction of tape hiss and system noise.

Tab. 3.2: Frequency allocation (instruments)

ULTRAGRAPH DIGITAL DEQ1024

4. INSTALLATION

4.1 Rack mounting

The BEHRINGER ULTRAGRAPH DIGITAL requires two height units (2 HU) for being installed into a 19" rack. Please allow at least an extra 4" of space for the connectors on the rear panel.

Also, please make sure that sufficient ventilation of the unit is provided for, and never put the device onto an amp or similar equipment to avoid overheating.

Please use M6 machine screws and nuts to install your DEQ1024 into a rack.

 **To disconnect your DEQ1024 from the mains, please pull the power cord out of the socket. When your unit is operational, always make sure you can easily access the power socket. If you install your DEQ1024 into a rack, please make sure that you can easily unplug the unit out of the wall socket or that you are using an extension cord with a power switch.**

4.2 Audio connections

You will need many different cables for the various applications. The following illustrations show how these cables should be laid out. Please use exclusively high-grade cables.

The audio connectors of the ULTRAGRAPH DIGITAL are electronically balanced and ensure automatic hum and noise reduction.

Of course, you can also connect equipment featuring unbalanced outputs. To this end, use either mono jacks or connect ring and sleeve of the stereo jack (bridge pin 1 and pin 3 when using XLR connectors).

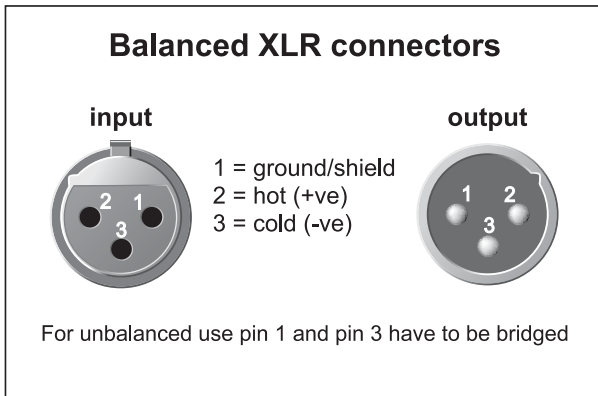

Fig. 4.1: XLR connections

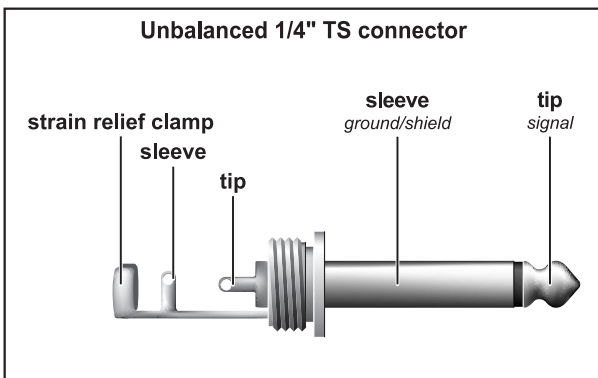

Fig. 4.2: 1/4" TS connector

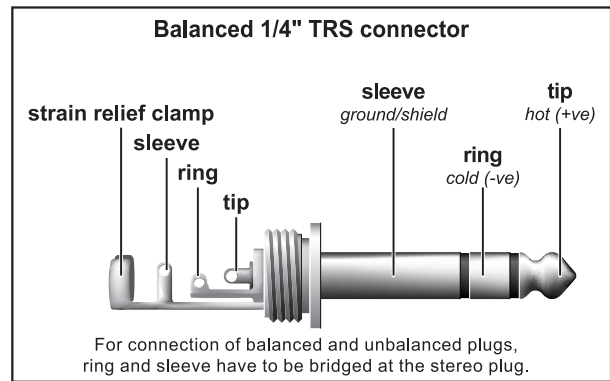

Fig. 4.3: 1/4" TRS connector

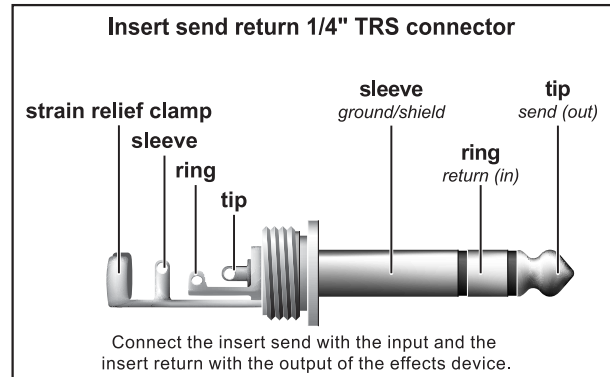

Fig. 4.4: 1/4" TRS connector for insert send/return applications

4.3 Digital connections (AES/EBU and S/PDIF)

The AES/EBU interface whose name is derived from the Audio Engineering Society and the European Broadcasting Union, is mainly used in professional studio environments and broadcasting studios for the transmission of digital signals, also over greater distances. The connection is made via balanced XLR cables with a wave resistance of 110 ohms. Cables can be up to 100 m long.

The interface complies with the AES3 format, which allows for the two-channel transmission of signals with a resolution of up to 24 bits. The signal has an auto-clock and auto-synchronization feature (important when several digital devices are used). An additional wordclock connection between DEQ1024 and connected AES/EBU equipment is therefore not required. The sample rate is not fixed and can be chosen freely. Typical rates are 44.1 kHz, 48 kHz, 88.2 kHz and 96 kHz. The AES/EBU interface is largely compatible with the popular S/PDIF interface. A connection can be made using an adapter.

ULTRAGRAPH DIGITAL DEQ1024

5. SPECIFICATIONS

ANALOG INPUTS

Type	electronically balanced
Connector	XLR
Impedance	22 k Ω at 1 kHz
Max. input level	+12 or +22 dBu, switchable
CMRR	80 dB typ.

ANALOG OUTPUTS

Type	servo-balanced
Connector	XLR
Impedance	100 Ω at 1 kHz
Max. output level	+12 or +22 dBu, switchable

SYSTEM SPECIFICATIONS

Frequency response	15 Hz to 35 kHz, +/- 3 dB
Signal-to-noise ratio	104 dBu, a-weighted, 22 Hz - 22 kHz
THD	0.004 % typ. @ +4 dBu, 1 kHz, gain 1
Crosstalk	< -85 dB, 22 Hz - 22 kHz

BYPASS

Type	Relay, hard-bypass in case of power failure
------	------------------------------------------------

DIGITAL INPUTS

Type	XLR transformer-balanced
Standard	AES/EBU or S/PDIF
Input impedance	110 Ω
Nom. input level	0.2 - 5 V peak-to-peak

DIGITAL OUTPUTS

Type	XLR transformer-balanced
Standard	AES/EBU or S/PDIF
Impedance	110 Ω
Output level	2 - 5 V peak-to-peak

DIGITAL PROCESSING

Converter	24-bit Delta-Sigma, 64/128 oversampling
Sample rate	44.1 kHz, 48 kHz, 96 kHz

GRAPHIC EQUALIZER

Type	analog 1/3-oct EQ
Frequency range	20 Hz to 20 kHz 31 1/3-oct. bands according to ISO frequencies
Bandwidth	1/3-oct.
Control range	+/-6, +/-12 dB or 0/-24 dB (switchable)

FEEDBACK DESTROYER (FBD)

Type	digital signal analysis for feedback identification
Filter	max. 10 digital notch filters per channel, automatic feedback suppression system
Frequency range	20 Hz - 20 kHz
Bandwidth	1/10-oct.
Control range	-48 dB in 6 dB-steps

MASTER

Gain	-9 dB to +9 dB
------	----------------

FILTER

Low Cut	20 Hz to 160 Hz (12 dB/oct.)
High Cut	2.5 kHz to 16 kHz (12 dB/oct.)

DYNAMICS

Type	gate and limiter with digital IGC (Interactive Gain Control)
Threshold	variable: -60 to -10 dB (gate) variable: -6 to +9 dB (limiter)

FUNCTION SWITCHES

Bypass	switch, to deactivate equalizer functions
Meter in/out	selects between input and output metering
Fader range	sets the maximal cut/boost for the 31 bands
Standby	switches into standby mode
Pink noise	-48 dB to 0 dB
FB indicator	recognition of frequency band intensity
True Curve	Algorithm for achieving filter curve linearity

DISPLAYS

Input/output level	12-digit LED display: -48/-36/-24/ -18/-12/-6/-3/0/+3/+6/+9 dB/CLIP
Function switch	LED display of each switch (except for clock and configuration switches)

POWER SUPPLY

Voltage	85 to 250 V~, 50/60 Hz, auto range
Power consumption	typ. 10 W
Fuse	T 1 A H
Mains connector	Standard IEC receptacle

DIMENSIONS/WEIGHT

Dimensions (H x W x D)	approx. 3.5" (89 mm) x 19" (482.6 mm) x 5.3" (135 mm)
Shipping weight	approx. 2.5 kg (5 lbs)

BEHRINGER continuously strives to assure the highest quality standards possible. Required modifications may be implemented without prior notice. Technical data and the appearance of the unit may deviate from the above values and/or illustrations.

ULTRAGRAPH DIGITAL DEQ1024

6. WARRANTY

§ 1 WARRANTY CARD/ONLINE REGISTRATION

To be protected by the extended warranty, the buyer must complete and return the enclosed warranty card within 14 days of the date of purchase to BEHRINGER Spezielle Studioteknik GmbH, in accordance with the conditions stipulated in § 3. Failure to return the card in due time (date as per postmark) will void any extended warranty claims. Based on the conditions herein, the buyer may also choose to use the online registration option via the Internet (www.behringer.com or www.behringer.de).

§ 2 WARRANTY

1. BEHRINGER (BEHRINGER Spezielle Studioteknik GmbH including all BEHRINGER subsidiaries listed on the enclosed page, except BEHRINGER Japan) warrants the mechanical and electronic components of this product to be free of defects in material and workmanship for a period of one (1) year* from the original date of purchase, in accordance with the warranty regulations described below. If the product shows any defects within the specified warranty period that are not excluded from this warranty as described under § 3 and 4, BEHRINGER shall, at its discretion, either replace or repair the product using suitable new or reconditioned parts. In the case that other parts are used which constitute an improvement, BEHRINGER may, at its discretion, charge the customer for the additional cost of these parts.

2. If the warranty claim proves to be justified, the product will be returned to the user freight prepaid.

3. Warranty claims other than those indicated above are expressly excluded.

§ 3 RETURN AUTHORIZATION NUMBER

1. To obtain warranty service, the buyer (or his authorized dealer) must call BEHRINGER (see enclosed list) during normal business hours **BEFORE** returning the product. All inquiries must be accompanied by a description of the problem. BEHRINGER will then issue a return authorization number.

2. Subsequently, the product must be returned in its original shipping carton, together with the return authorization number to the address indicated by BEHRINGER.

3. Shipments without freight prepaid will not be accepted.

§ 4 WARRANTY REGULATIONS

1. Warranty services will be furnished only if the product is accompanied by a copy of the original retail dealer's invoice. Any product deemed eligible for repair or replacement by BEHRINGER under the terms of this warranty will be repaired or replaced within 30 days of receipt of the product at BEHRINGER.

2. If the product needs to be modified or adapted in order to comply with applicable technical or safety standards on a national or local level, in any country which is not the country for which the product was originally developed and manufactured, this modification/adaptation shall not be considered a defect in materials or workmanship. The warranty does not cover any such modification/adaptation, irrespective of whether it was carried out properly or not. Under the terms of this warranty, BEHRINGER shall not be held responsible for any cost resulting from such a modification/adaptation.

3. Free inspections and maintenance/repair work are expressly excluded from this warranty, in particular, if caused by improper handling of the product by the user. This also applies to defects caused by normal wear and tear, in particular, of faders, potentiometers, keys/buttons and similar parts.

4. Damages/defects caused by the following conditions are not covered by this warranty:

▲ improper handling, neglect or failure to operate the unit in compliance with the instructions given in BEHRINGER user or service manuals.

▲ connection or operation of the unit in any way that does not comply with the technical or safety regulations applicable in the country where the product is used.

▲ damages/defects caused by force majeure or any other condition that is beyond the control of BEHRINGER.

5. Any repair or opening of the unit carried out by unauthorized personnel (user included) will void the warranty.

6. If an inspection of the product by BEHRINGER shows that the defect in question is not covered by the warranty, the inspection costs are payable by the customer.

7. Products which do not meet the terms of this warranty will be repaired exclusively at the buyer's expense. BEHRINGER will inform the buyer of any such circumstance. If the buyer fails to submit a written repair order within 6 weeks after notification, BEHRINGER will return the unit C.O.D. with a separate invoice for freight and packing. Such costs will also be invoiced separately when the buyer has sent in a written repair order.

§ 5 WARRANTY TRANSFERABILITY

This warranty is extended exclusively to the original buyer (customer of retail dealer) and is not transferable to anyone who may subsequently purchase this product. No other person (retail dealer, etc.) shall be entitled to give any warranty promise on behalf of BEHRINGER.

§ 6 CLAIM FOR DAMAGES

Failure of BEHRINGER to provide proper warranty service shall not entitle the buyer to claim (consequential) damages. In no event shall the liability of BEHRINGER exceed the invoiced value of the product.

§ 7 OTHER WARRANTY RIGHTS AND NATIONAL LAW

1. This warranty does not exclude or limit the buyer's statutory rights provided by national law, in particular, any such rights against the seller that arise from a legally effective purchase contract.

2. The warranty regulations mentioned herein are applicable unless they constitute an infringement of national warranty law.

* Customers in the European Union please contact BEHRINGER Germany Support for further details.

The information contained in this manual is subject to change without notice. No part of this manual may be reproduced or transmitted in any form or by any means, electronic or mechanical, including photocopying and recording of any kind, for any purpose, without the express written permission of BEHRINGER Spezielle Studioteknik GmbH.

BEHRINGER is a registered trademark. ALL RIGHTS RESERVED. © 2003 BEHRINGER Spezielle Studioteknik GmbH.
BEHRINGER Spezielle Studioteknik GmbH, Hanns-Martin-Schleyer-Str. 36-38, 47877 Willich-Münchheide II, Germany
Tel. +49 2154 9206 0, Fax +49 2154 9206 4903

FEDERAL COMMUNICATIONS COMMISSION COMPLIANCE INFORMATION

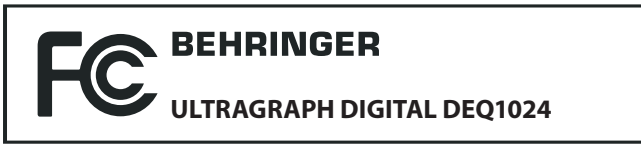

Responsible party name: **MUSIC Group Services USA, Inc.**
Address: **18912 North Creek Parkway,
Suite 200 Bothell, WA 98011,
USA**
Phone/Fax No.: **Phone: +1 425 672 0816
Fax: +1 425 673 7647**

ULTRAGRAPH DIGITAL DEQ1024

complies with the FCC rules as mentioned in the following paragraph:

This equipment has been tested and found to comply with the limits for a Class B digital device, pursuant to part 15 of the FCC Rules. These limits are designed to provide reasonable protection against harmful interference in a residential installation. This equipment generates, uses and can radiate radio frequency energy and, if not installed and used in accordance with the instructions, may cause harmful interference to radio communications. However, there is no guarantee that interference will not occur in a particular installation. If this equipment does cause harmful interference to radio or television reception, which can be determined by turning the equipment off and on, the user is encouraged to try to correct the interference by one or more of the following measures:

- Reorient or relocate the receiving antenna.
- Increase the separation between the equipment and receiver.
- Connect the equipment into an outlet on a circuit different from that to which the receiver is connected.
- Consult the dealer or an experienced radio/TV technician for help.

This device complies with Part 15 of the FCC rules. Operation is subject to the following two conditions:

- (1) this device may not cause harmful interference, and
- (2) this device must accept any interference received, including interference that may cause undesired operation.

Important information:

Changes or modifications to the equipment not expressly approved by MUSIC Group can void the user's authority to use the equipment.